

VOLT E WATT

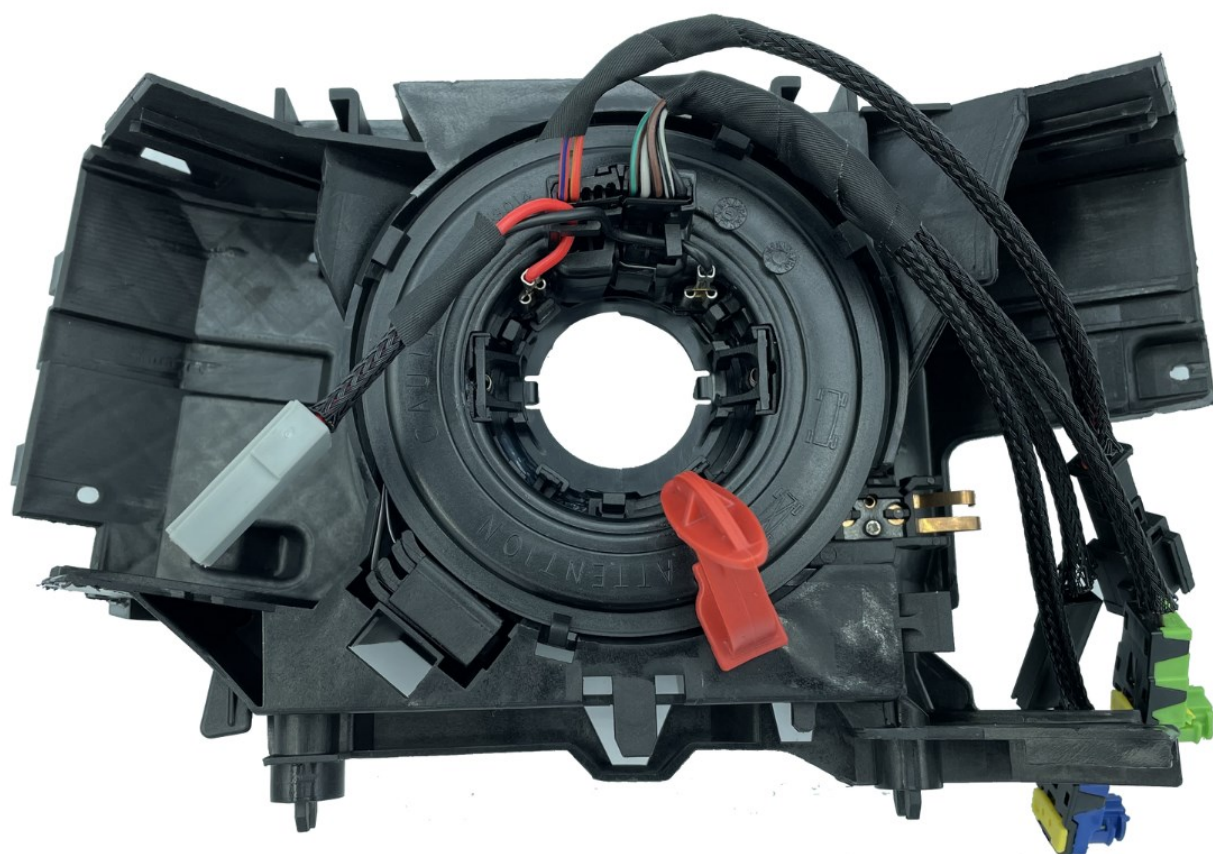

**MOLLE
SPIROELICOIDALI**

2022

CODICE

BRAND

APPLICAZIONE

MSA11001



Audi



SEAT

AUDI A4 B6 - A4 B7
A4 B7 AVANT - A6 ALLROAD
A6 C6 - AVANT - A8 - Q7
SEAT EXEO



MSA11002



BMW SERIE 5 (E60)
5 Touring (E61) - 6 (E63)
6 Cabriolet (E64)

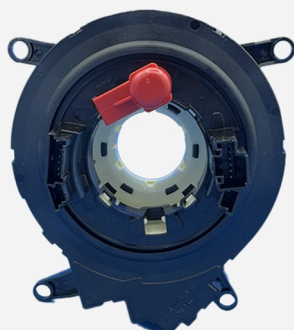

MSA11003



BMW SERIE 5 (E60)
5 Touring (E61) - 6 (E63)
6 Cabriolet (E64)
7 (E65, E66, E67)



CODICE

BRAND

APPLICAZIONE

MSA11004



BMW 1 E81/E87 2003
3 E90/E91 2005
X1 E84 2009
X5 E70 2007
X6 E71/E72 2007



MSA11005



SERIE BMW 3 (E46) - 5 (E39)
X3 (E83) - X5 (E53)
Z4 Coupè (E86)
Z4 Roadster (E85)

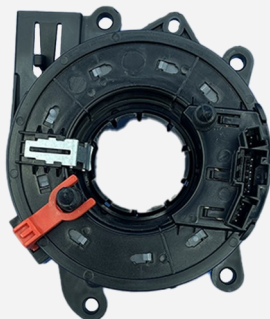

MSA11006



DODGE CALIBER
JEEP GRAND CHEROKEE
WRANGLER - PATRIOT
LIBERTY - COMPASS



CODICE

BRAND

APPLICAZIONE

MSA11007



FORD FOCUS II
FOCUS C-MAX - TRANSIT

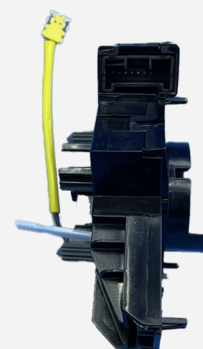

MSA11008



FORD MONDEO III

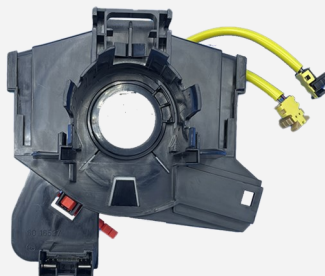
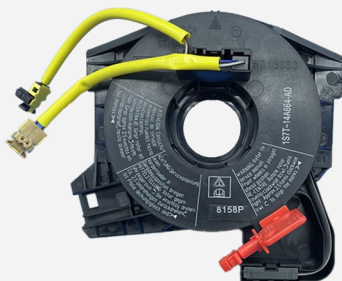

MSA11009



FORD MONDEO IV

CODICE

BRAND

APPLICAZIONE

MSA11010



FORD FOCUS III/C-MAX/
TRANSIT CONNECT

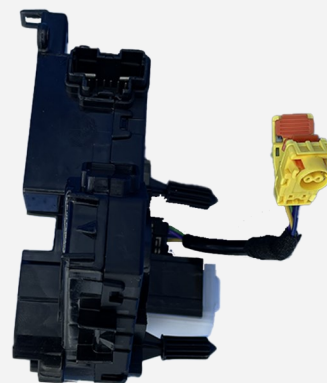
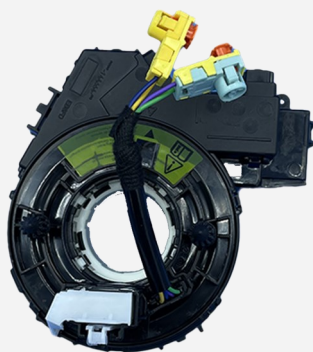

MSA11011



FORD FIESTA - KA - PUMA

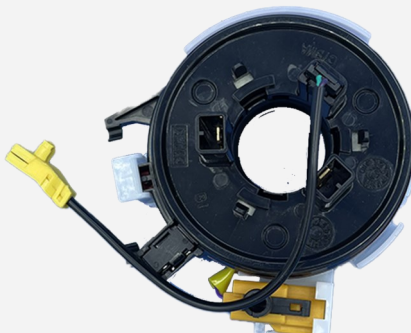
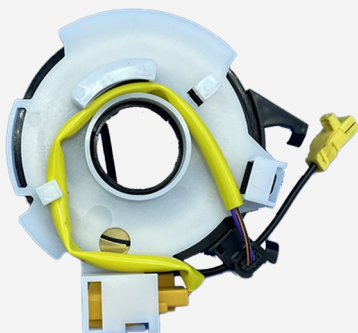

MSA11012



FORD FOCUS III - KUGA
TRANSIT CONNECT

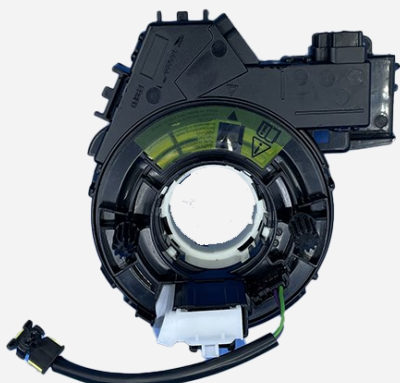

CODICE

BRAND

APPLICAZIONE

MSA11130



FORD MONDEO V 2014



CODICE BRAND APPLICAZIONE

MSA11017



FIAT 500X - TIPO
JEEP RENEGADE



MSA11018



HONDA ACCORD VII

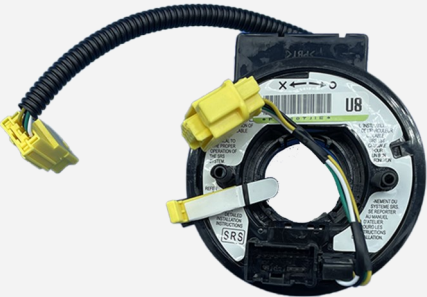

MSA11019



HONDA ACCORD VII



CODICE	BRAND	APPLICAZIONE
--------	-------	--------------

MSA11020



HONDA CIVIC VIII - CR-V III



MSA11021



HONDA ACCORD VIII

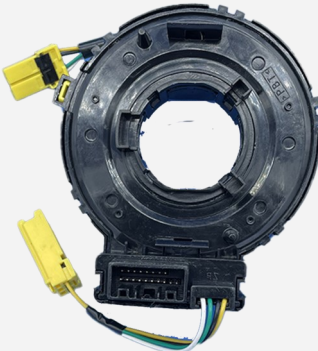

MSA11022



HONDA CR-V II



CODICE BRAND APPLICAZIONE

MSA11023



HONDA ACCORD - CIVIC



MSA11024



HONDA JAZZ - CITY



MSA11025



HONDA CIVIC VIII - CIVIC X
CR V I - CR-V III - CR V IV



CODICE

BRAND

APPLICAZIONE

MSA11026



HONDA JAZZ - HR-V

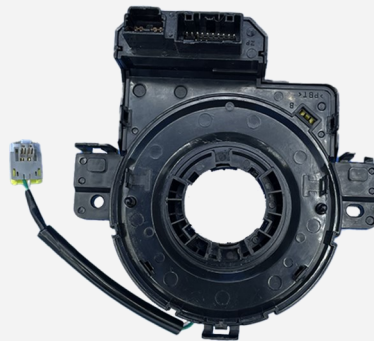
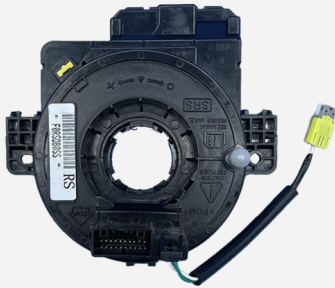

MSA11027



HONDA CR-V III/CIVIC



MSA11028



HYUNDAI SANTA FE II
SANTA FE III



CODICE BRAND APPLICAZIONE

MSA11029



HYUNDAI SANTA FE II



MSA11030



HYUNDAI ix35 - SOUL I
SPORTAGE

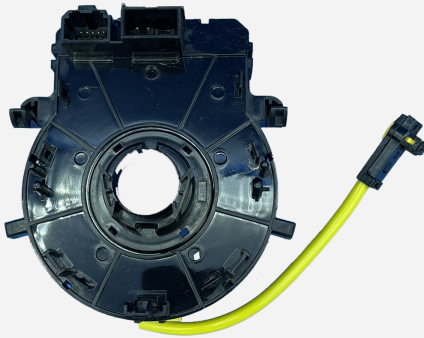

MSA11031



HYUNDAI i20



CODICE

BRAND

APPLICAZIONE

MSA11032



HYUNDAI TUCSON
SPORTAGE - ELANTRA - ix20
CEE'D - PRO CEE'D - ix35
SOUL I - CEE'D - PRO CEE'D



MSA11033



HYUNDAI ELANTRA - ix20
CEED - PRO CEED

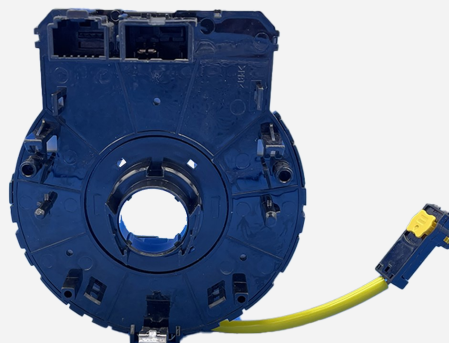

MSA11034



HYUNDAI IX35 - SOUL I CEED
PRO CEED - SPORTAGE
VENGA

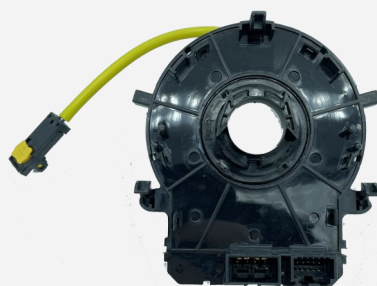

CODICE

BRAND

APPLICAZIONE

MSA11035

HYUNDAI

HYUNDAI SANTA FE III
GRAND SANTA FE

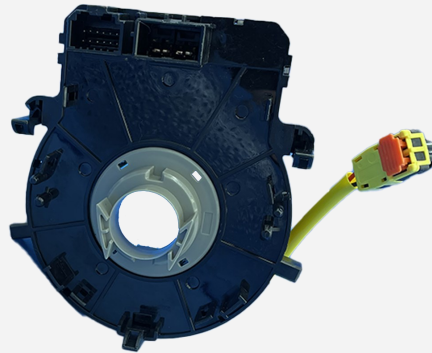

MSA11036

 
HYUNDAI

HYUNDAI I10/I20
SORENTO II



MSA11038

 
HYUNDAI

HYUNDAI i30 - ELANTRA
CEED - PRO CEED

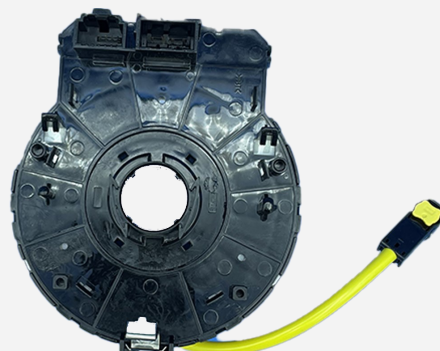

CODICE

BRAND

APPLICAZIONE

MSA11039



HYUNDAI i20/SORENTO II



MSA11040



HYUNDAI i40/CEED

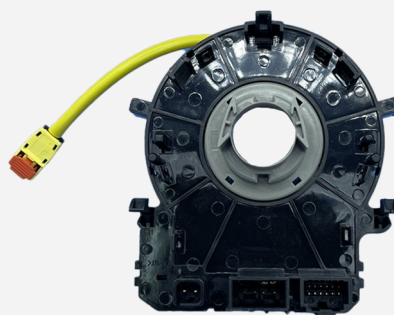
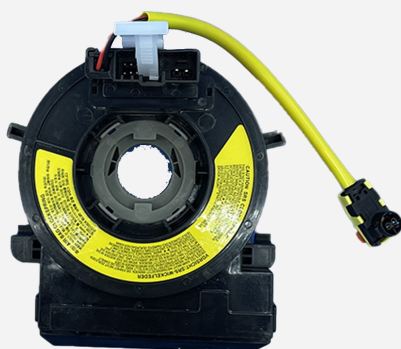

MSA11041



HYUNDAI i30/CEED

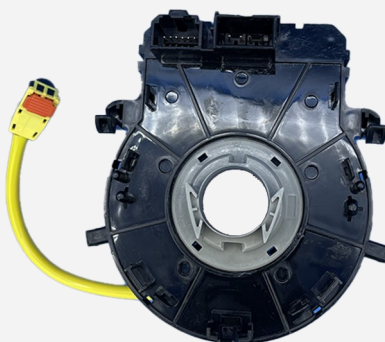

CODICE

BRAND

APPLICAZIONE

MSA11042



KIA CARENS

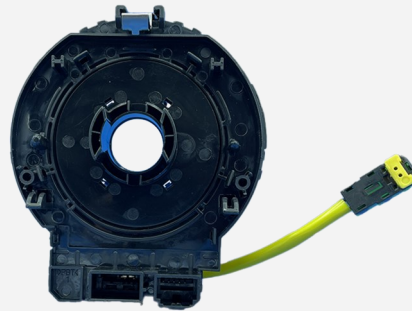

MSA11043



KIA RIO III

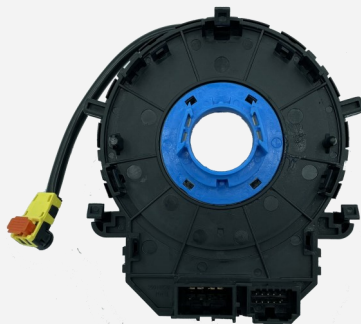

MSA11044



KIA OPTIMA

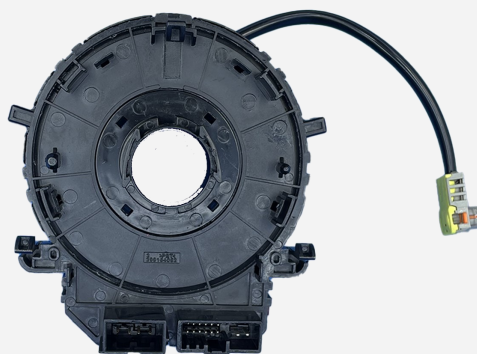

CODICE

BRAND

APPLICAZIONE

MSA11045



HYUNDAI TUCSON - ix35
SPORTAGE



MSA11046



KIA SORENTO

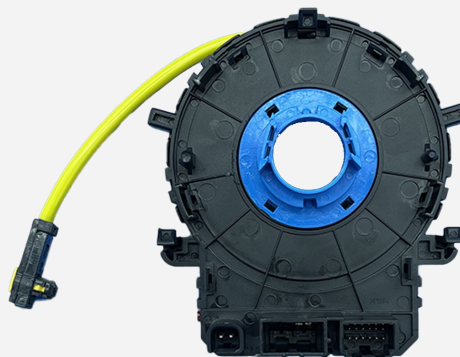

MSA11133



HYUNDAI i30 - KIA SOUL
SPORTAGE - VENZA



CODICE BRAND APPLICAZIONE

MSA11047



LAND ROVER DISCOVERY III
RANGE ROVER EVOQUE
RANGE ROVER SPORT

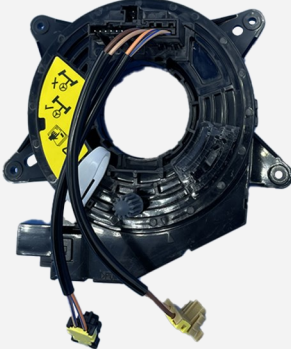

CODICE

BRAND

APPLICAZIONE

MSA11048



LAND ROVER FREELANDER



MSA11049



LAND ROVER FREELANDER 2

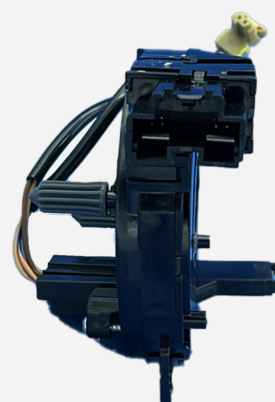

MSA11050



MERCEDES CLASSE G (W463)
GL (X164) - M (W164) ML - R
CLS (C219) -SLK - E (W211)

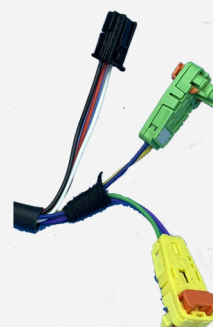

CODICE

BRAND

APPLICAZIONE

MSA11051



MERCEDES CLASSE C (W202)
CLK (C208) - CLASSE E (W210)



MSA11052



MERCEDES CLASSE E (W211)
CLASSE E T-MODEL (S211)
CLASSE G (W463)



MSA11053



MERCEDES CLASSE C (W203)
CLK (C209)



MOLLE SPIROELICOIDALI AIRBAG

CODICE	BRAND	APPLICAZIONE
--------	-------	--------------

MSA11054



MITSUBISHI LANCER VII
PAJERO III - OUTLANDER



MSA11055



MITSUBISHI L200 - LANCER VII
LANCER VIII

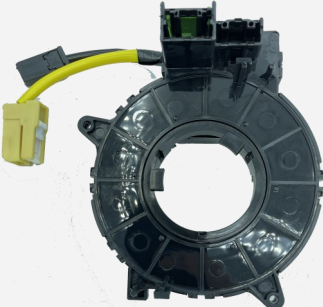

MSA11056



MITSUBISHI L200 - LANCER
OUTLANDER



CODICE

BRAND

APPLICAZIONE

MSA11057



MITSUBISHI ASX - L200
OUTLANDER



MSA11058



MITSUBISHI PAJERO II



MSA11059



MITSUBISHI COLT



CODICE	BRAND	APPLICAZIONE
--------	-------	--------------

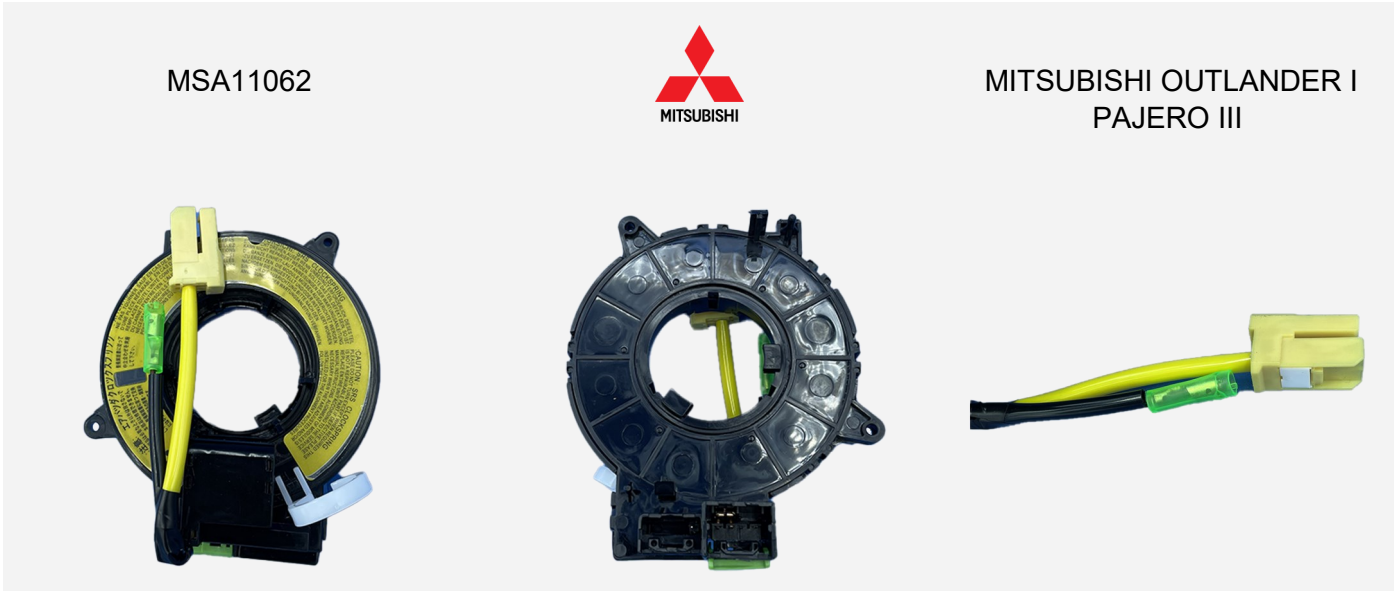
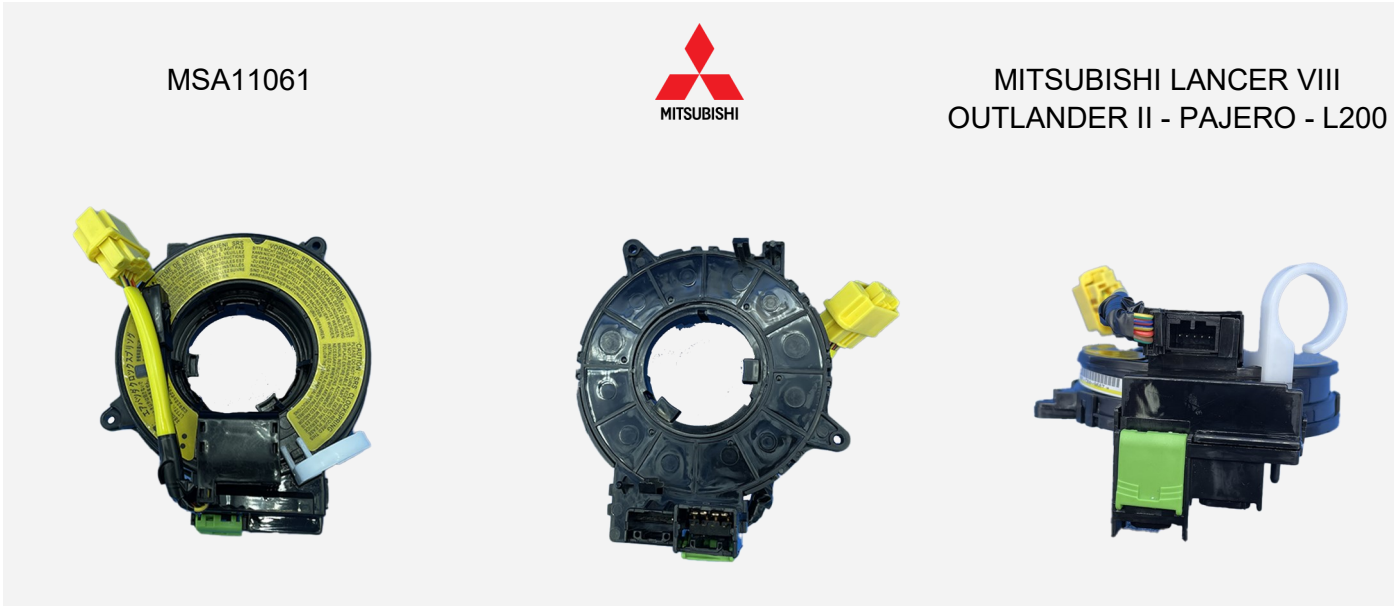
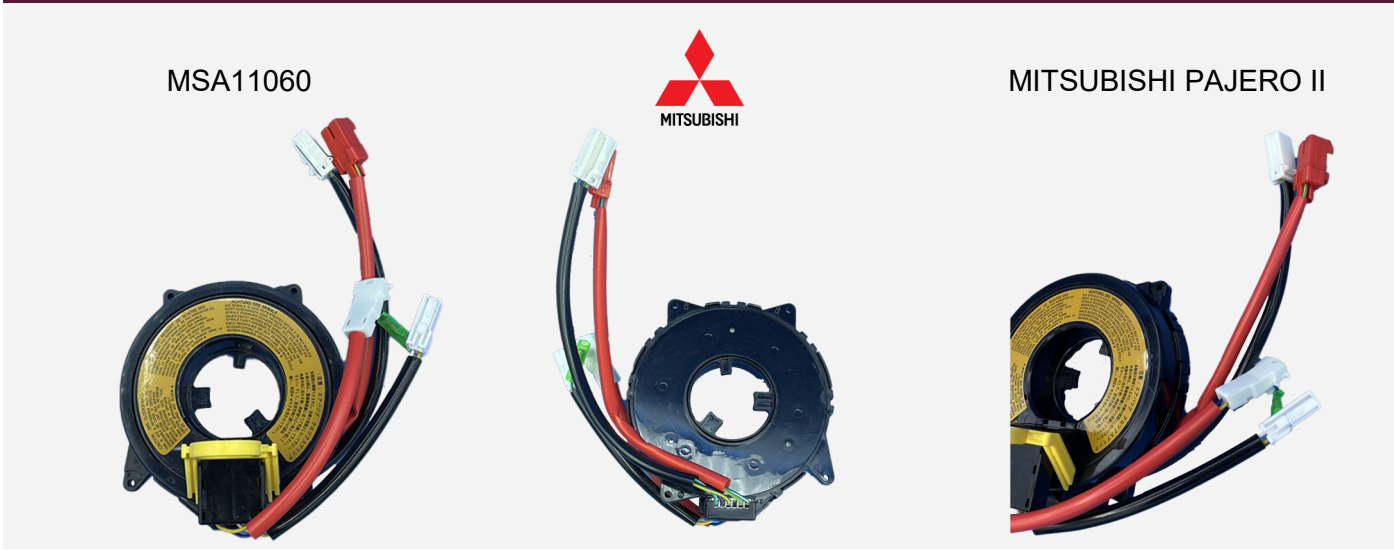

CODICE

BRAND

APPLICAZIONE

MSA11063



MITSUBISHI OUTLANDER III
PAJERO

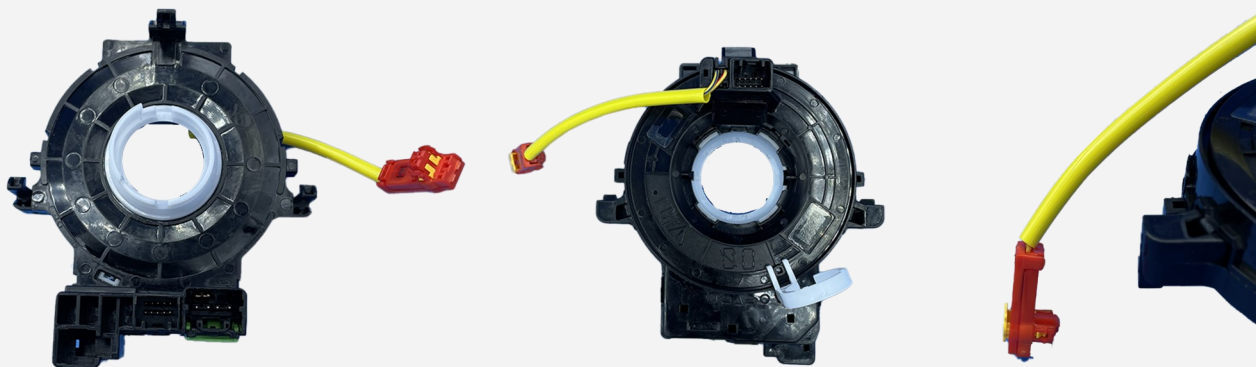

MSA11064



MITSUBISHI L200

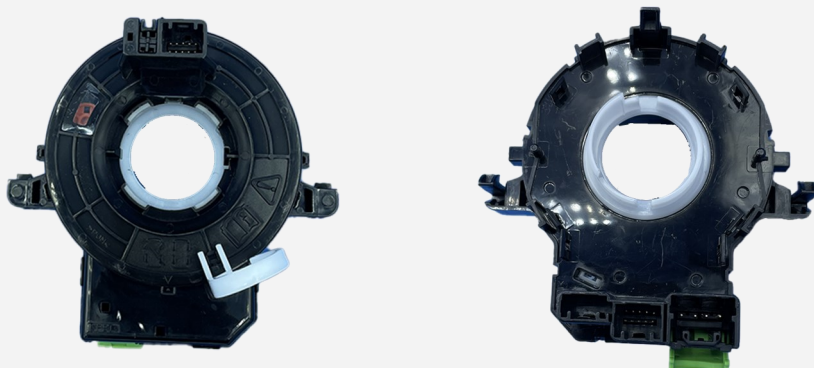

MSA11065



MAZDA 6/RX-8



CODICE BRAND APPLICAZIONE

MSA11066



MAZDA 2 - 6



MSA11067



MAZDA 3

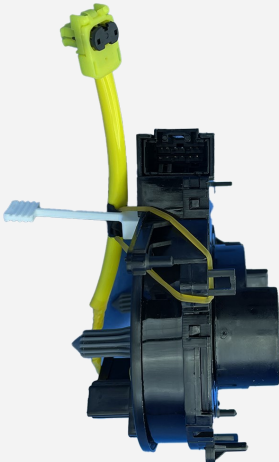

MSA11068



MAZDA 3

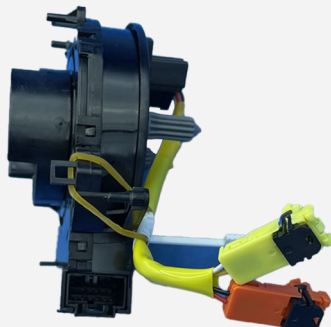
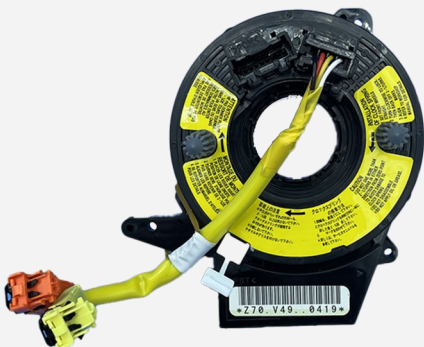

CODICE	BRAND	APPLICAZIONE
--------	-------	--------------

MSA11069



MAZDA 6 - RX-8 - CX-9



MSA11070



NISSAN NAVARA D40
MURANO- PATHFINDER R51
QASHQAI - X TRAIL

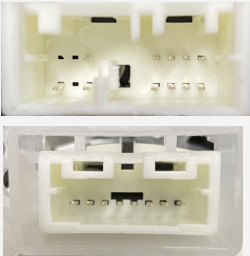
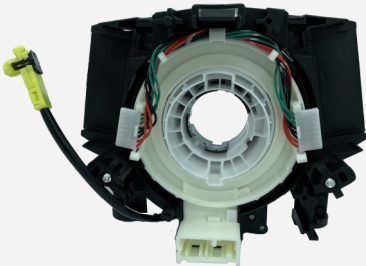







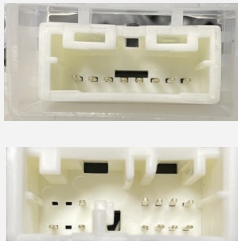
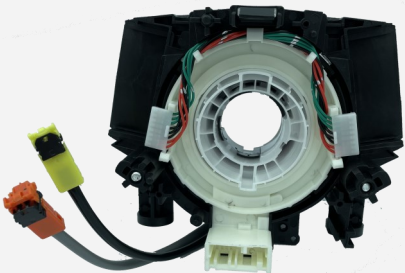

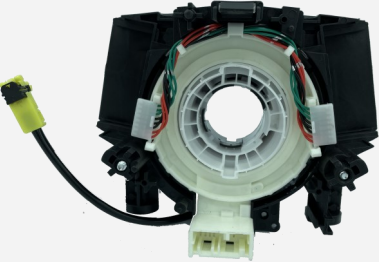

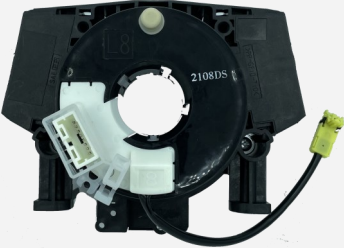
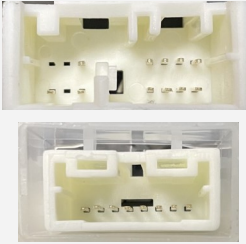

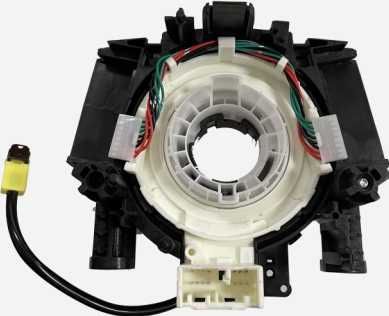
MSA11071

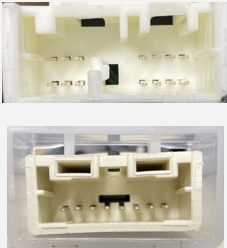

NISSAN NAVARA D40
MURANO- PATHFINDER R51
QASHQAI - X TRAIL



CODICE	BRAND	APPLICAZIONE
<p>MSA11072</p> 	 	<p>NISSAN NAVARA D40 NOTE E11- PATHFINDER R51 QASHQAI</p>  
<p>MSA11073</p> 	 	<p>NISSAN NOTE E11 2009 QASHQAI</p>  
<p>MSA11074</p> 	 	<p>NISSAN QASHQAI J11 PULSAR C13</p> 

CODICE

BRAND

APPLICAZIONE

MSA11075



INFINITI FX
NISSAN MICRA K13
JUKE F15 - MURANO

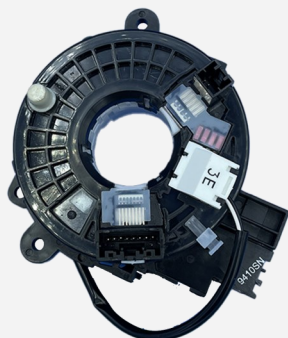

MSA11076



NISSAN PICK UP D22



MSA11077



NISSAN X-TRAIL T30T

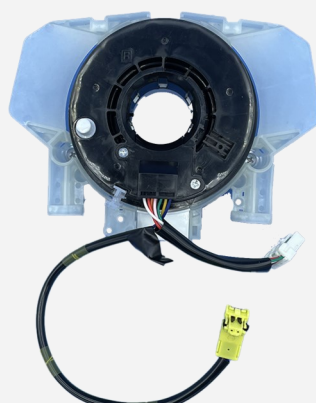
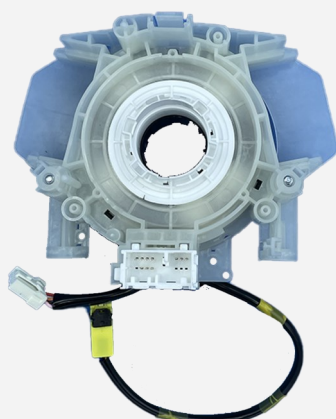

CODICE

BRAND

APPLICAZIONE

MSA11079



NISSAN X-TRAIL T31

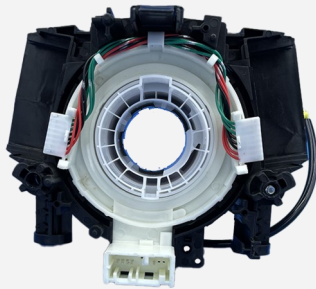

MSA11080



CHEVROLET CRUZE
ORLANDO
OPEL ADAM (M13) - ASTRA J
CASCADA (W13)
ZAFIRA TOURER C (P12)



MSA11081



CHEVROLET CRUZE
ORLANDO - OPEL INSIGNIA

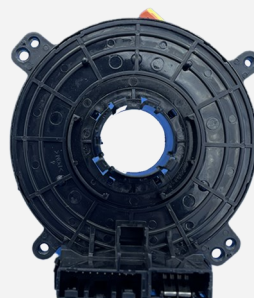

CODICE

BRAND

APPLICAZIONE

MSA11082



CHEVROLET CRUZE
ORLANDO
OPEL ADAM (M13) - ASTRA J
CASCADA (W13)
ZAFIRA TOURER C (P12)



MSA11083



CHEVROLET CRUZE (J300)
CRUZE (J305)
OPEL ASTRA K (B16)

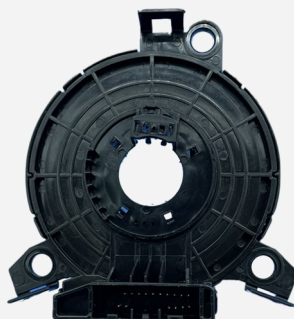

MSA11084



OPEL COMBO (71)
ASTRA F/G/H
CALIBRA A (C89) - CORSA A/B
TIGRA - VECTRA A B
ZAFIRA A



CODICE

BRAND

APPLICAZIONE

MSA11088



RENAULT MEGANE II
(BM0/1_, CM0/1)

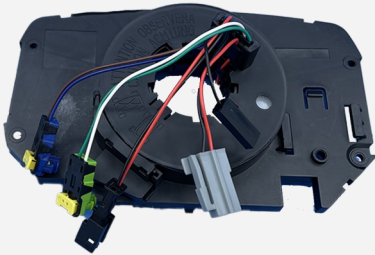

MSA11089



DACIA DUSTER (HS_)
LOGAN (LS_) - SANDERO



MSA11090



DACIA DOKKER - DUSTER
LOGAN II - SANDERO II
OPEL VIVARO B
RENAULT CAPTUR - TRAFIC III
TWINGO 3



CODICE

BRAND

APPLICAZIONE

MSA11091



RENAULT

RENAULT CLIO III - KANGOO
 GRAND KANGOO (KW0/1_)
 KANGOO BE BOP (KW0/1_)
 MODUS - GRAND MODUS

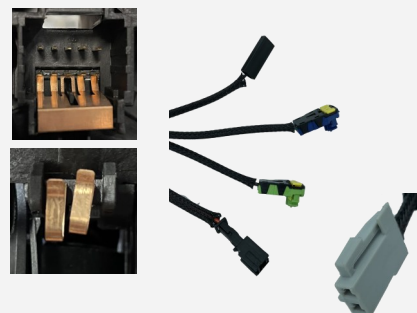
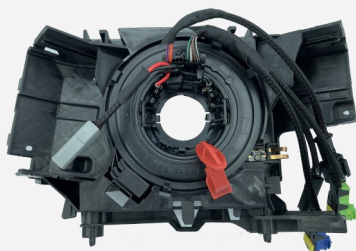

MSA11092



RENAULT

DACIA DUSTER - LOGAN
 SANDERO - RENAULT CLIO IV

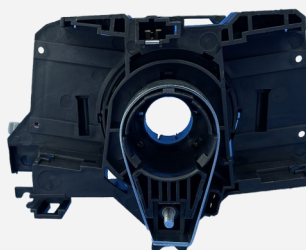
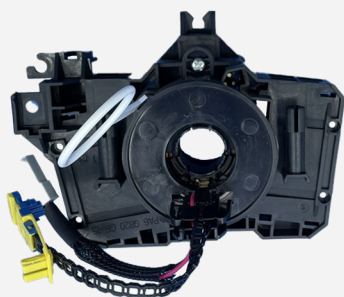

MSA11093



RENAULT

RENAULT CLIO II (BB_, CB_)
 THALIA I (LB_)

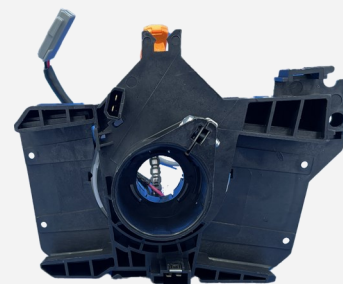
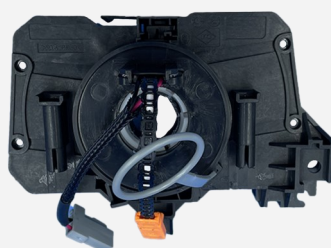

CODICE

BRAND

APPLICAZIONE

MSA11094



SUBARU LEGACY - OUTBACK



MSA11095



SUBARU FORESTER
IMPREZA

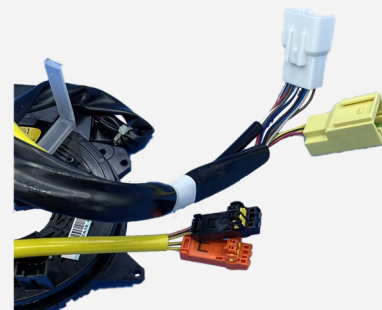
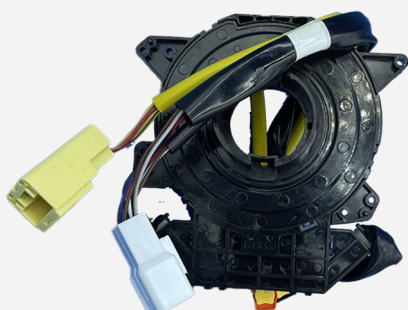

MSA11096



SUBARU LEGACY - OUTBACK-
FORESTER - IMPREZA



CODICE

BRAND

APPLICAZIONE

MSA11097



SUBARU FORESTER
IMPREZA

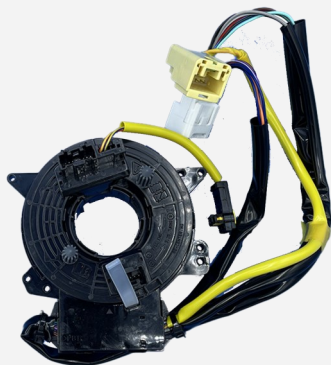

MSA11098



SUBARU LEGACY - OUTBACK

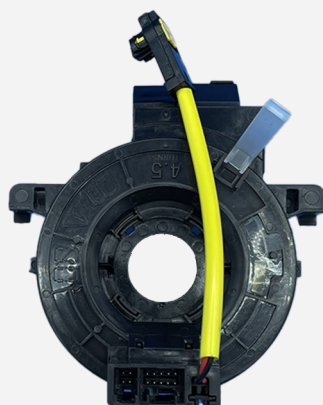

MSA11099



SUBARU FORESTER



CODICE	BRAND	APPLICAZIONE
--------	-------	--------------

MSA11100



SEAT ARONA - IBIZA V - Mii
 TOLEDO IV - SKODA CITIGO
 RAPID
 VW POLO VI (AW1, BZ1) - UP!



MSA11101



SUZUKI SX4 - SWIFT - ALTO



MSA11102



SUZUKI GRAND VITARA
 SWIFT



CODICE

BRAND

APPLICAZIONE

MSA11103



SUZUKI SX4 - SWIFT

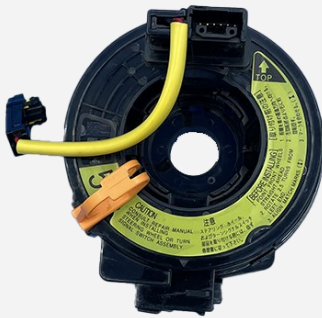

MSA11104



TOYOTA COROLLA - RAV4
YARIS



MSA11105



TOYOTA HILUX

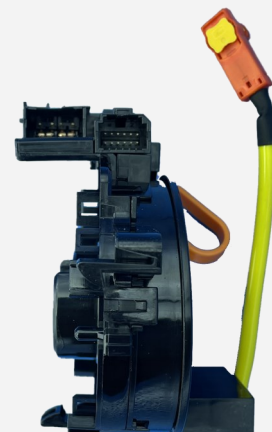

CODICE

BRAND

APPLICAZIONE

MSA11106



TOYOTA YARIS - VERSO S

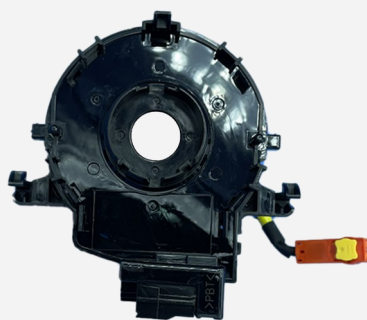

MSA11107



TOYOTA COROLLA



MSA11108



LEXUS IS 250/300/350
RX 300/330/350 - RX400H
TOYOTA RAV4
LAND CRUISER

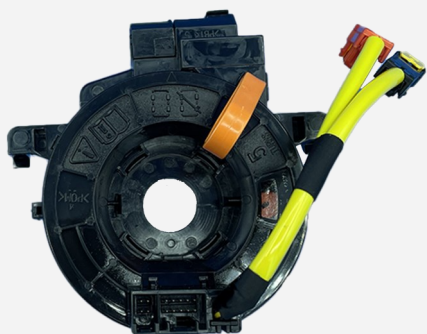

CODICE BRAND APPLICAZIONE

MSA11109



TOYOTA LAND
CRUISER PRADO

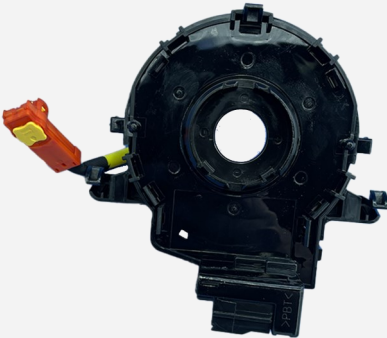

MSA11110



TOYOTA YARIS
YARIS VERSO - COROLLA
RAV4 - MR2



MSA11111



TOYOTA AVENSIS
AVENSIS VERSO - CAMRY
COROLLA - PREVIA



CODICE BRAND APPLICAZIONE

MSA11112



LEXUS LX470
TOYOTA LAND
CRUISER PRADO
LAND CRUISER 100



MSA11113



TOYOTA LAND CRUISER

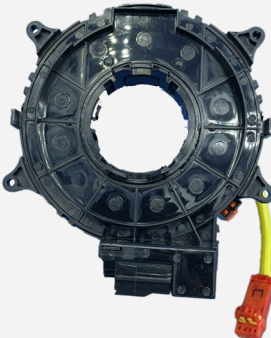

MSA11114



TOYOTA HILUX

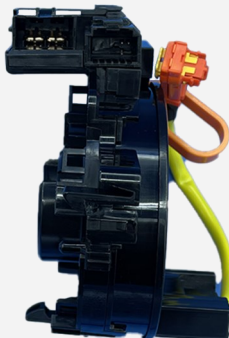

CODICE

BRAND

APPLICAZIONE

MSA11115



TOYOTA COROLLA
COROLLA VERSO - YARIS
CELICA - AVENSIS VERSO
PREVIA - RAV4



MSA11116



TOYOTA AVENSIS - COROLLA
COROLLA VERSO

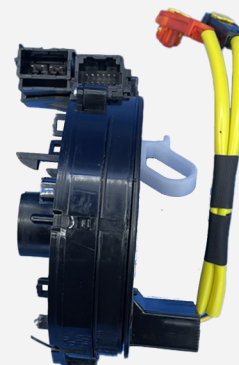

MSA11117



TOYOTA AURIS - AYGO
AYGO II - COROLLA - YARIS



CODICE BRAND APPLICAZIONE

MSA1118



TOYOTA COROLLA - MR2
CELICA - PREVIA



MSA1119



LEXUS IS200
TOYOTA COROLLA - RAV4
LAND CRUISER

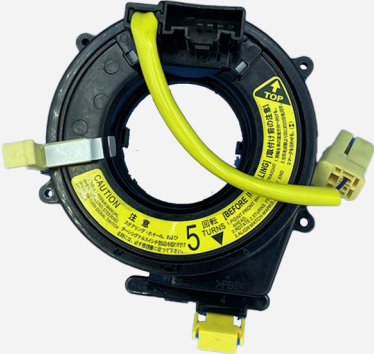

MSA1120



TOYOTA COROLLA VERSO
MR2 - CELICA



CODICE BRAND APPLICAZIONE

MSA11121



TOYOTA AVENSIS - COROLLA



MSA11122



TOYOTA YARIS
YARIS VERSO - COROLLA
MR2 - RAV4

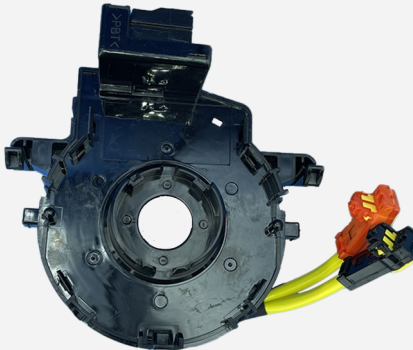

MSA11123



TOYOTA YARIS



CODICE

BRAND

APPLICAZIONE

MSA11124



TOYOTA YARIS - PRIUS
PRIUS PLUG-IN - VERSO S /IQ

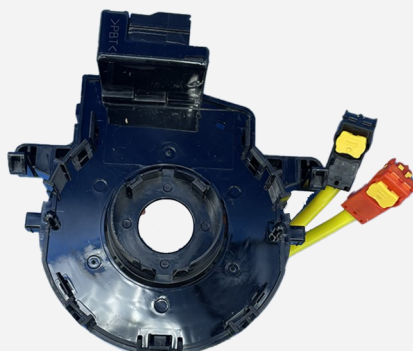

MSA11125



SEAT AROSA - CORDOBA
IBIZA II - INCA -
SKODA TOLEDO
VW GOLF III - LUPO - PASSAT
POLO - VENTO

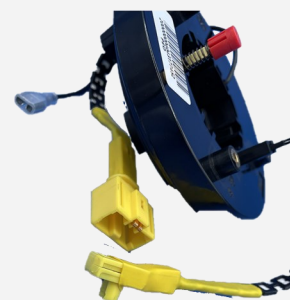

MSA11126



AUDI A3/A4/A6/A8
ALHAMBRA - LEON - TOLEDO
FABIA - OCTAVIA
VW BORA - FOX - GOLF IV
PASSAT



CODICE

BRAND

APPLICAZIONE

MSA11127



AUDI A3
SEAT ALTEA - LEON - TOLEDO
SKODA OCTAVIA - YETI
VW EOS - GOLF PLUS V
GOLF V E VI - TIGUAN

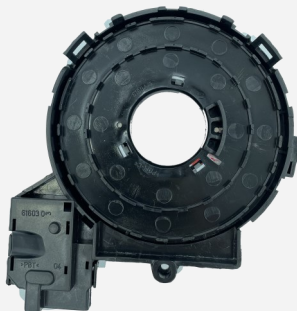

MSA11129



SEAT IBIZA IV - Mii
SKODA CITIGO - FABIA
VW AMAROK - MULTIVAN V/VI
POLO V - TRANSPORTER - UP!

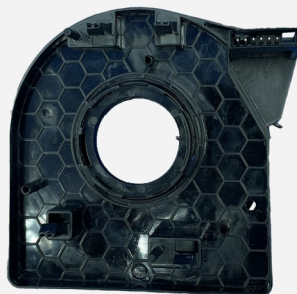

MSA11128



VW PASSAT B6 (3C2)S7B)

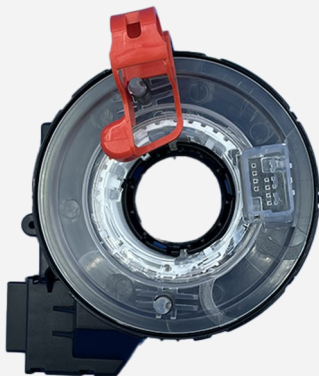

CODICE	BRAND	APPLICAZIONE
--------	-------	--------------

MSA11136



OPEL CORSA C - COMBO C
MERIVA A - TIGRA B

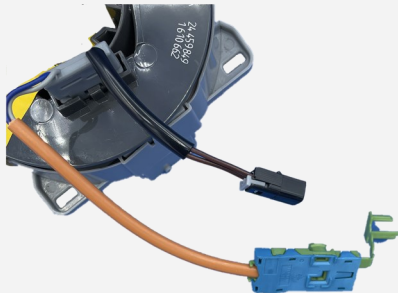
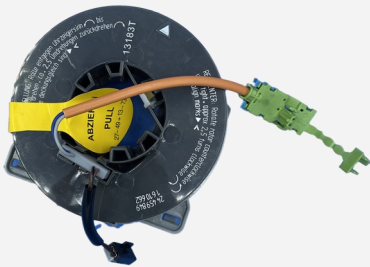
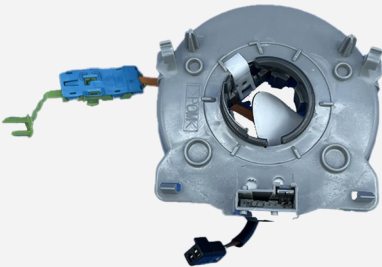

MSA11137



OPEL ASTRA F (T92)
CORSA B (S93) - TIGRA

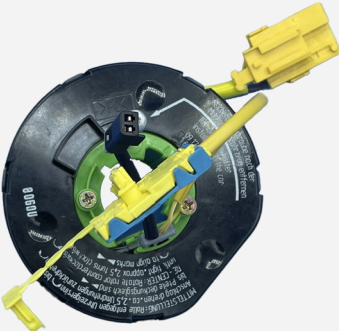
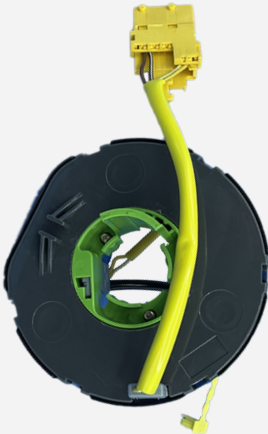

MSA11138



OPEL ASTRA F (T92)
CORSA B (S93) - TIGRA

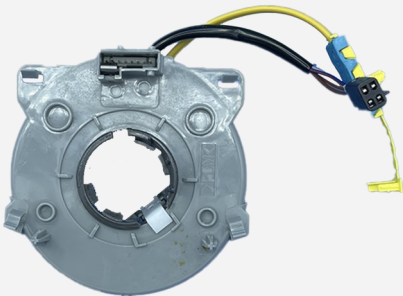

VOLT E WATT

THINK ELECTRIC

DISTRIBUITO DA:



Contrada Salice 11 - 80021 Afragola (NA)
Tel +39 0818691492 / 8510863
info@remarc.it - www.remarc.it